

Using a Walker

Walking with a Walker

1. Lift the walker and place it at a comfortable distance in front of you with all four of its legs on the floor. This distance is often equal to an arm's length.



2. Move your injured or weak leg toward the walker first. If you have had surgery on both legs, use either leg to begin walking.



3. Then take a step with your good leg, bringing it ahead of the injured or weak leg.



4. Repeat steps 1-3.

Safety Tips

- **Do not step too close to the walker because you may lose your balance.** There should be space between you and the walker at all times.
- **Hold your head up and look straight ahead.** Do not watch your feet. It is more tiring and you may run into something.
- **Walk slowly.**

Sitting with a Walker

1. **Slowly** back up to the chair, bed or toilet until you feel it against the back of your legs.



2. Let go of the walker with one hand and reach back for the chair arms or toilet seat, while sliding your injured or weak leg forward.



3. **Slowly** lower yourself to the seat by leaning forward and keeping your injured or weak leg straight out in front of you. Go slowly so that you do not land heavy in the chair.



4. If you have had surgery on both legs, place both hands on the chair arms, bed or commode seat. Lower yourself to the seat and slowly walk both legs forward. Do not land heavy in the chair.

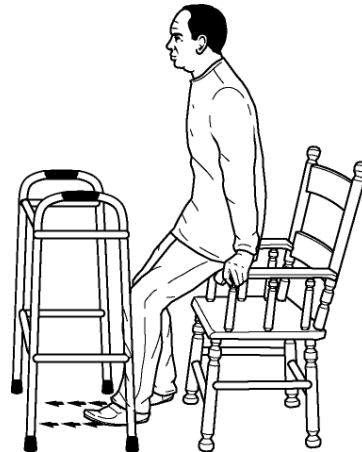

Stairs

Do not use your walker on stairs unless **your physical therapist has instructed you and practiced this with you.** Have someone help you on the stairs until you feel comfortable using your walker.

Going Up Stairs with a Walker

When climbing stairs, start with your good leg going up, and start with your injured or weak leg going down. **Up with the good, down with the bad.** When going up and down stairs with a walker, you should have a sturdy handrail.

1. Walk up to the stairs and place your feet about six inches from the first step.

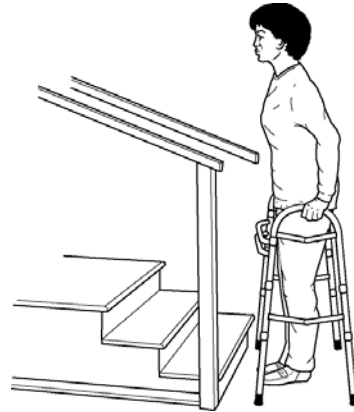

2. Fold the walker and place it in one hand. Place your other hand on the rail.

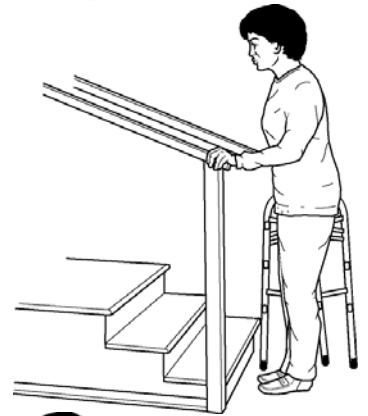

3. Lift the folded walker and set it to the back of the step. Step up first with your good leg.

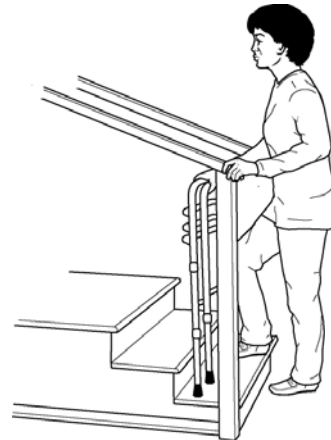

4. Bring up your injured or weak leg.

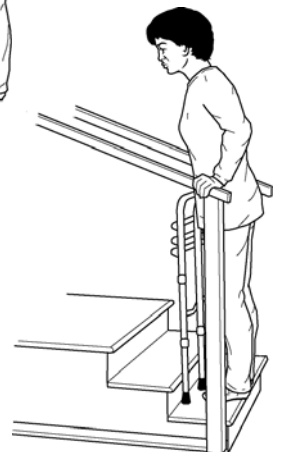

5. At the top of the stairs, unfold the walker and set it on the landing. Make sure you hear the walker click into the locked position. Place both hands on the walker.



6. Step up first with your good leg, and then bring up your injured or weak leg.



Going Down Stairs with a Walker

1. Walk up to the stairs and place your walker about two inches from the top step.

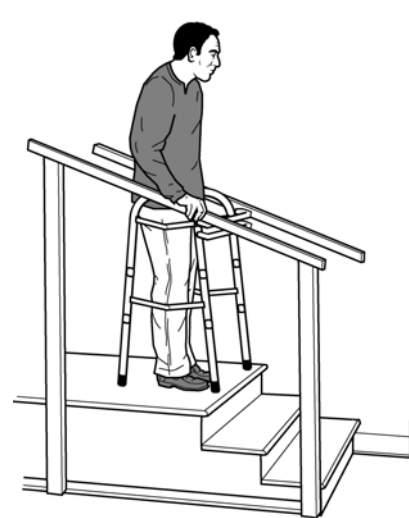

2. Fold the walker and place it in one hand.
Place your other hand on the rail.

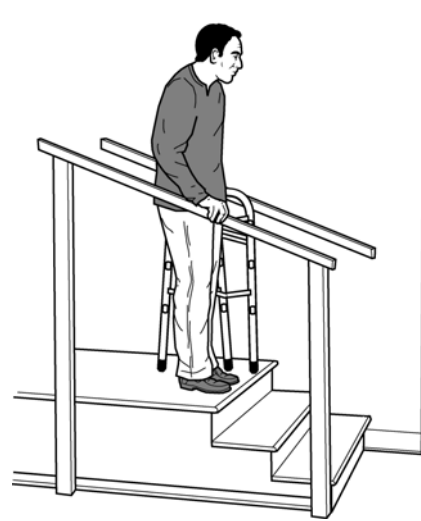

3. Set the folded walker down and near the front edge of the first step.



4. Step down first with your injured or weak leg, and then bring down your good leg.

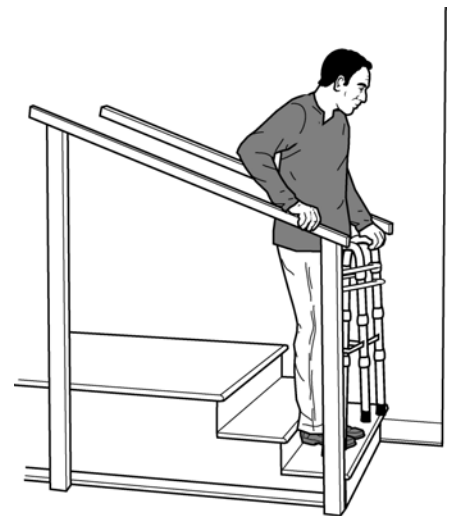
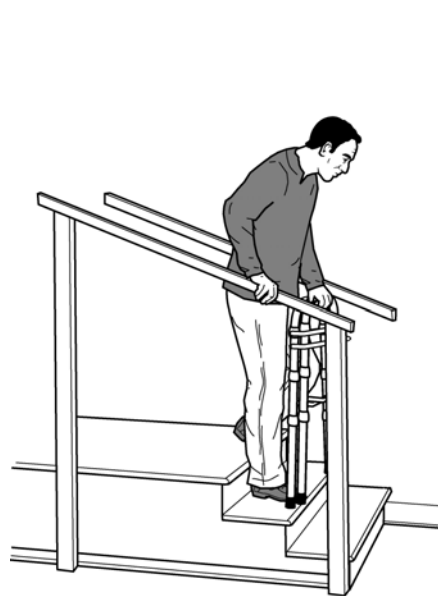

5. At the bottom of the stairs, unfold the walker and set it on the landing. Make sure you hear the walker click into the locked position.



6. Place both hands on the walker. Step down first with your injured or weak leg and then with your good leg.

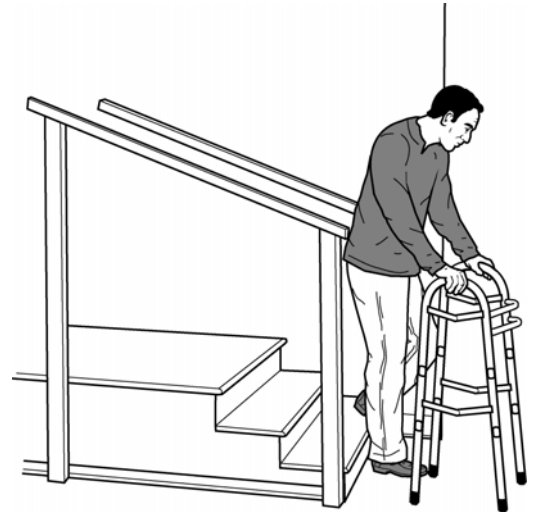

Going Up a Curb with a Walker

Forward Method

- Walk up to the curb.
- Put all four legs of the walker up on the curb.
- Push straight down on the walker when stepping up with the good leg.
- Step up with the injured or weak leg.

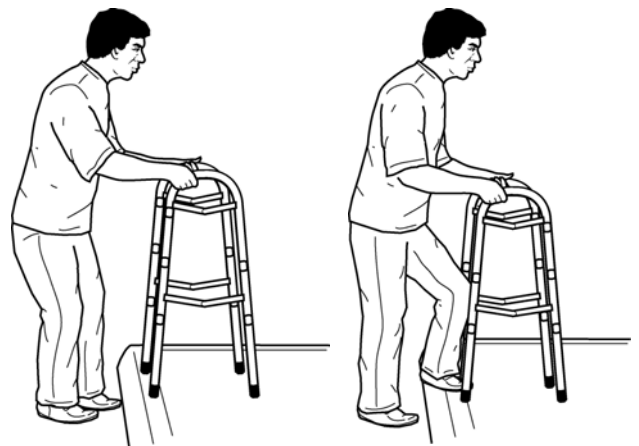

Backward Method

- Walk up to the curb and turn so your back is to the curb.
- Step up on the curb with your good leg.
- Step up on the curb with your injured or weak leg.
- Lift the walker and put all four legs up on the curb.
- Turn back around carefully.

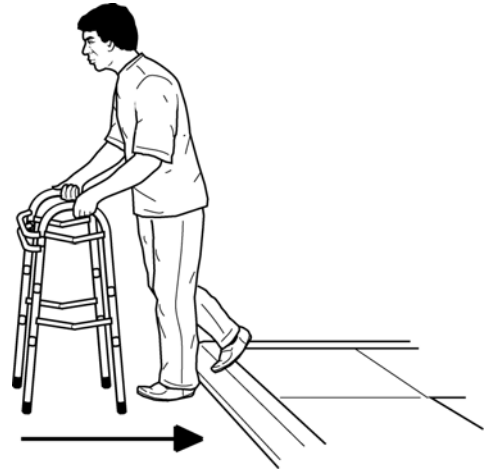

Going Down a Curb with a Walker

Never go down a curb backwards.

- Walk up to the edge of the curb.
- Put all four legs of the walker on the ground below.
- Step down with your injured or weak leg, then your good leg.



Talk to your doctor, nurse or physical therapist if you have any questions or concerns.